

PERANCANGAN STRUKTUR BANGUNAN SEDERHANA



STRUKTUR BANGUNAN SEDERHANA
GENAP 2020/2021

INDAH PUJIYANTI, S.T.,M.Sc



GRID STRUKTUR

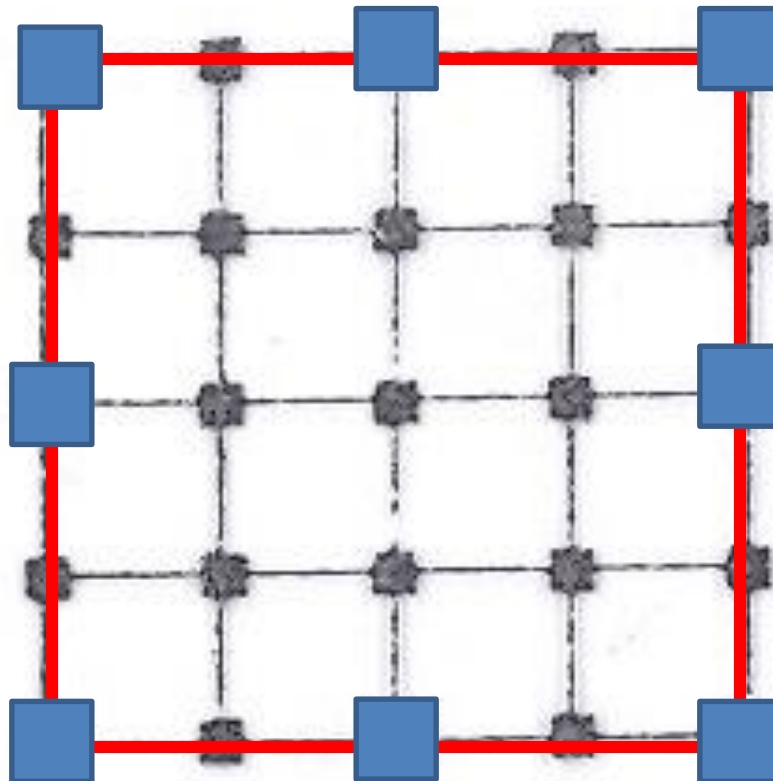

Rangka melintang dua arah

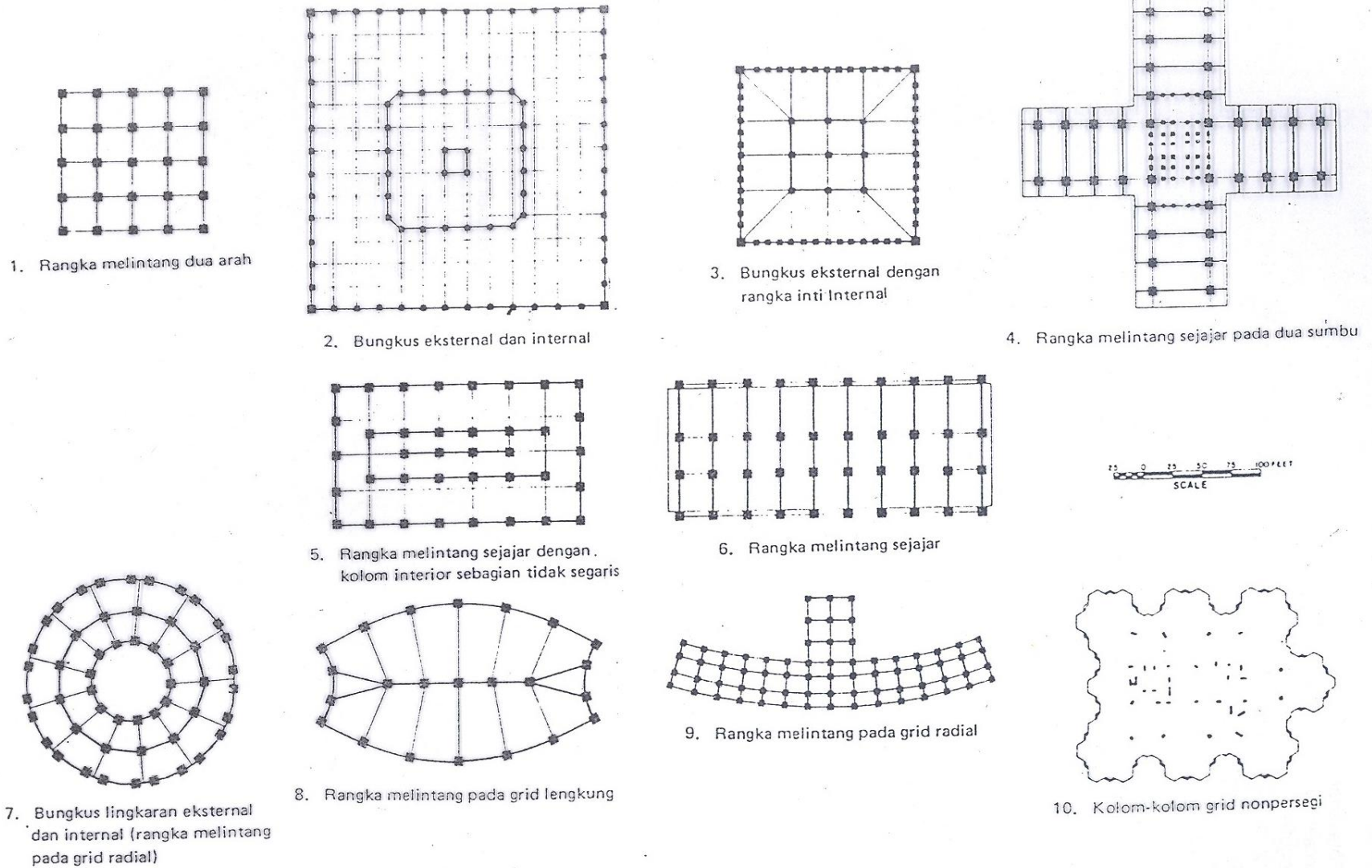

Gbr. 5.10: Sistem struktur rangka

BENTUK STRUKTUR SEDERHANA DAN SIMETRIS:

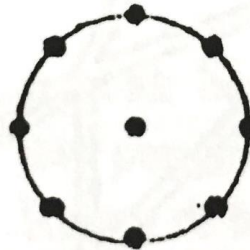
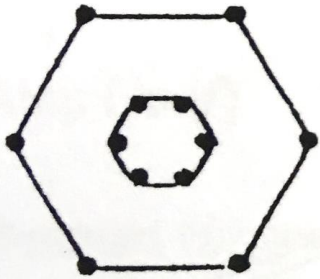
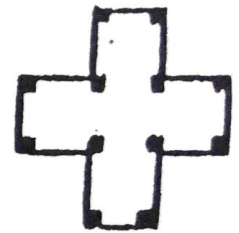
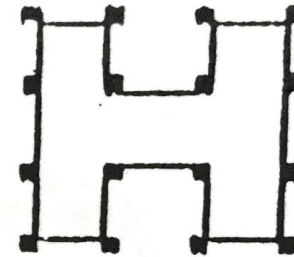
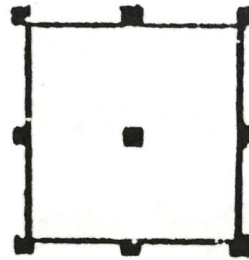
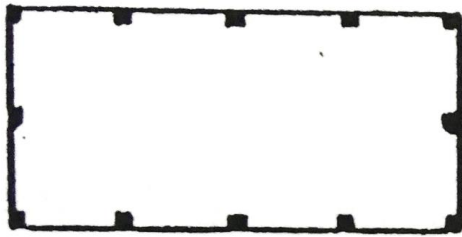

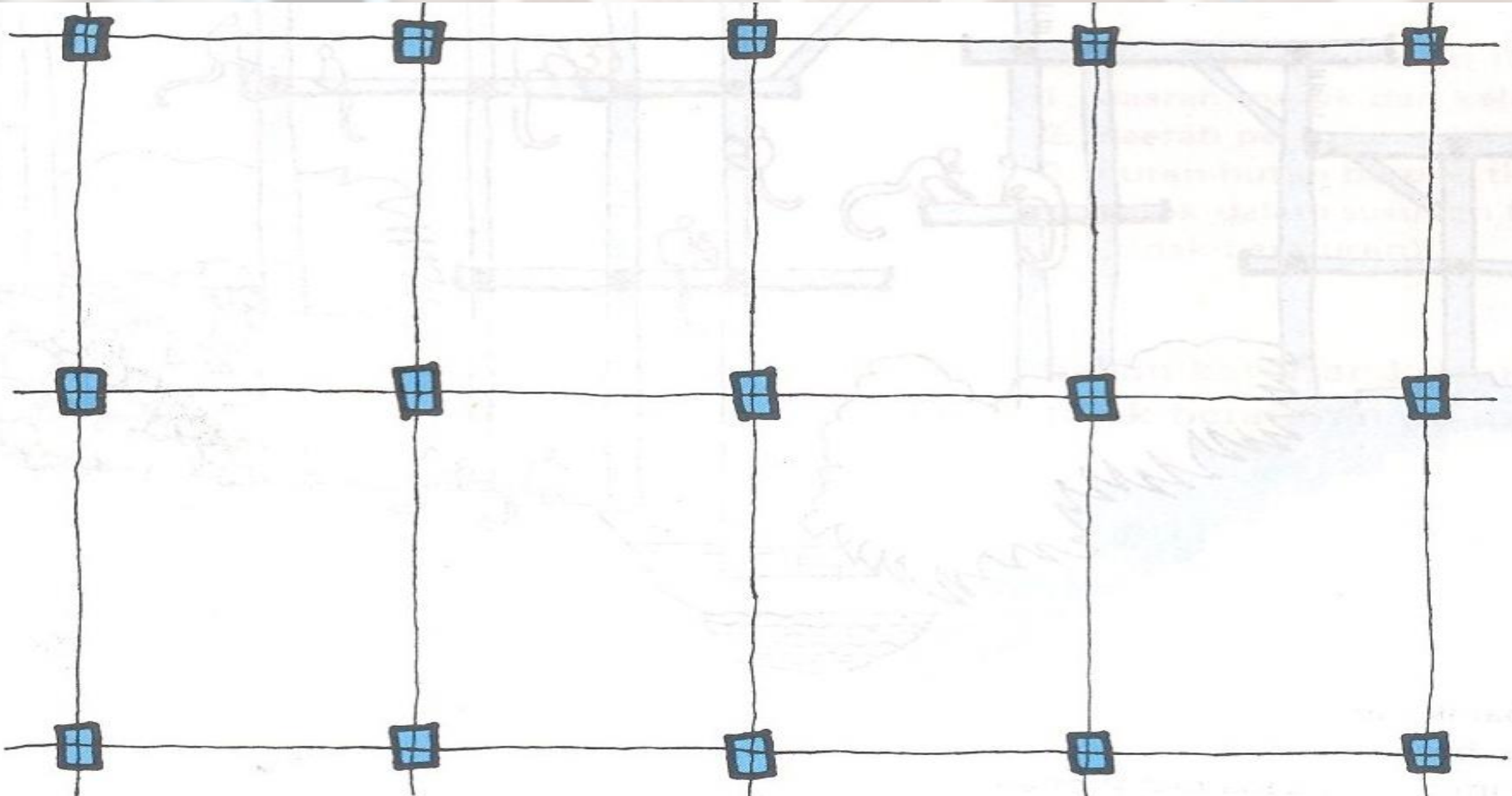

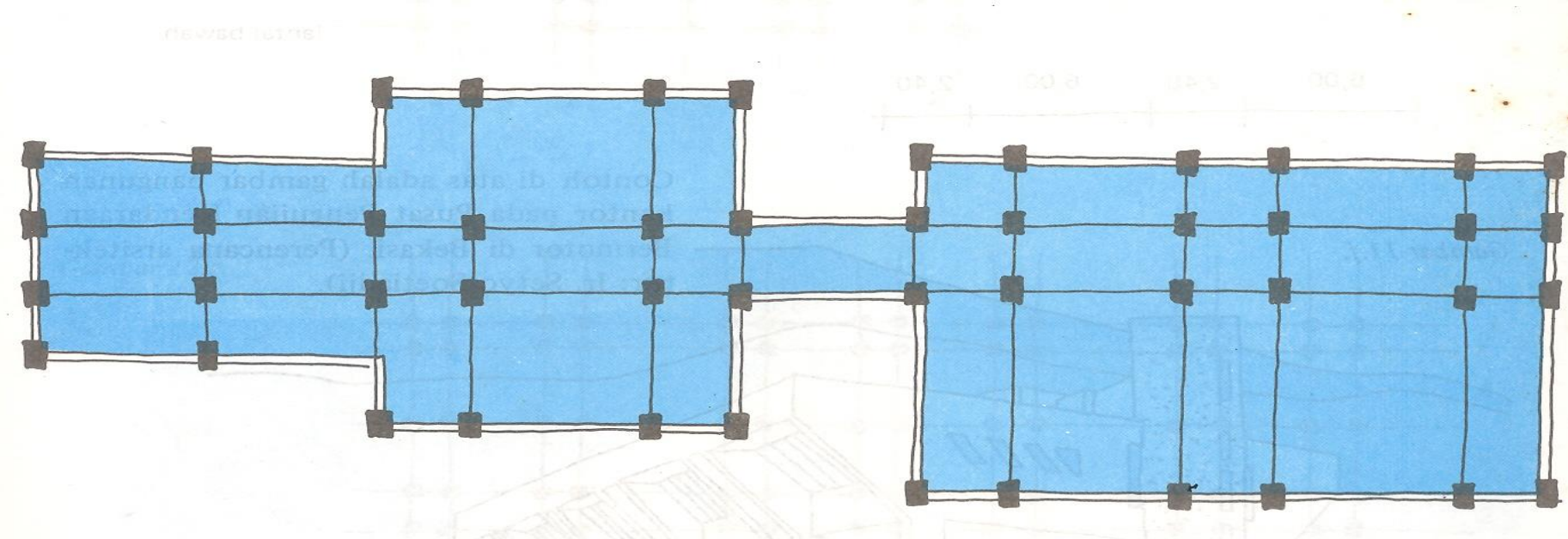

Contoh Grid pada denah persegi

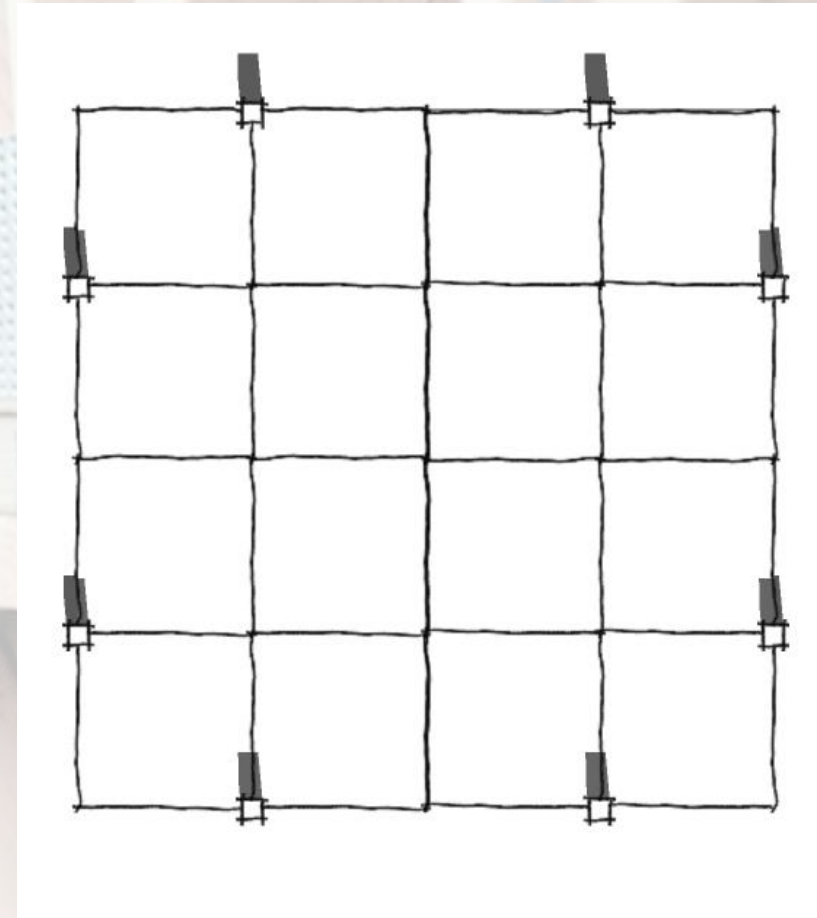
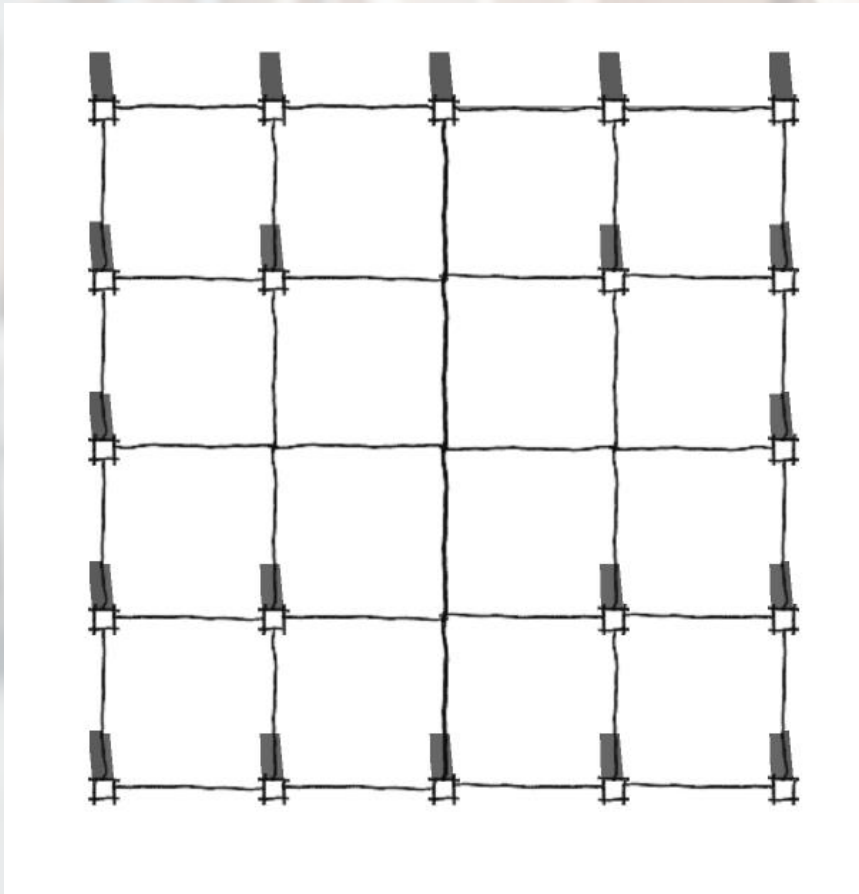

Perpaduan struktur kolom dengan Dinding pemikul

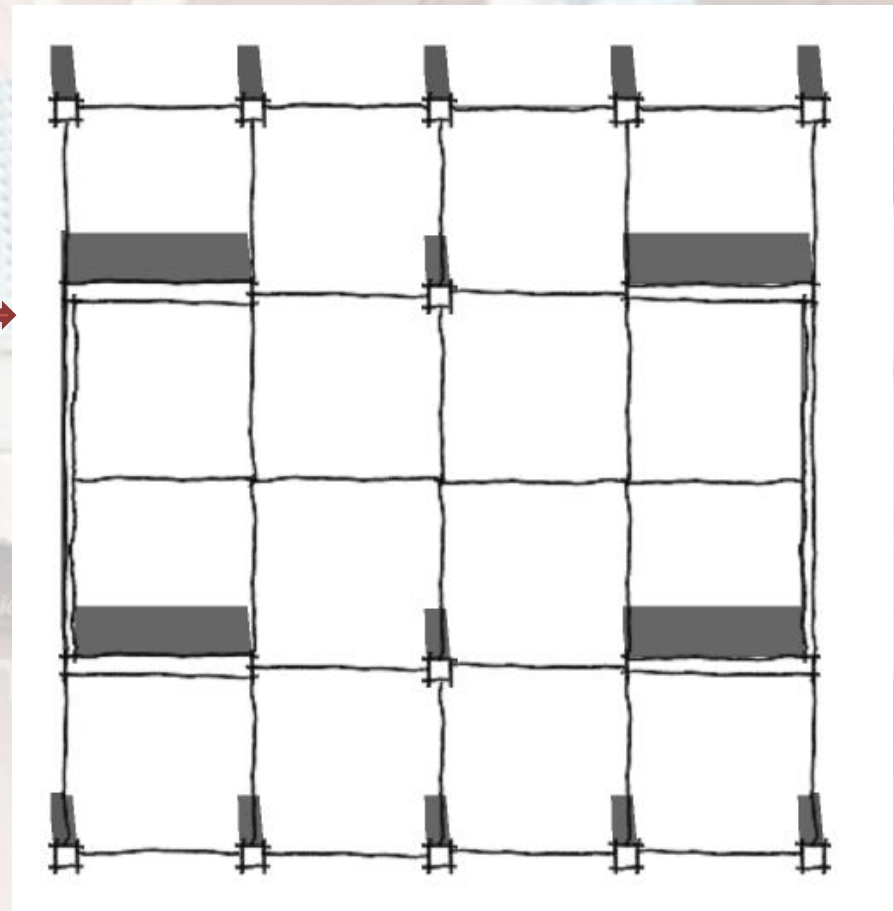
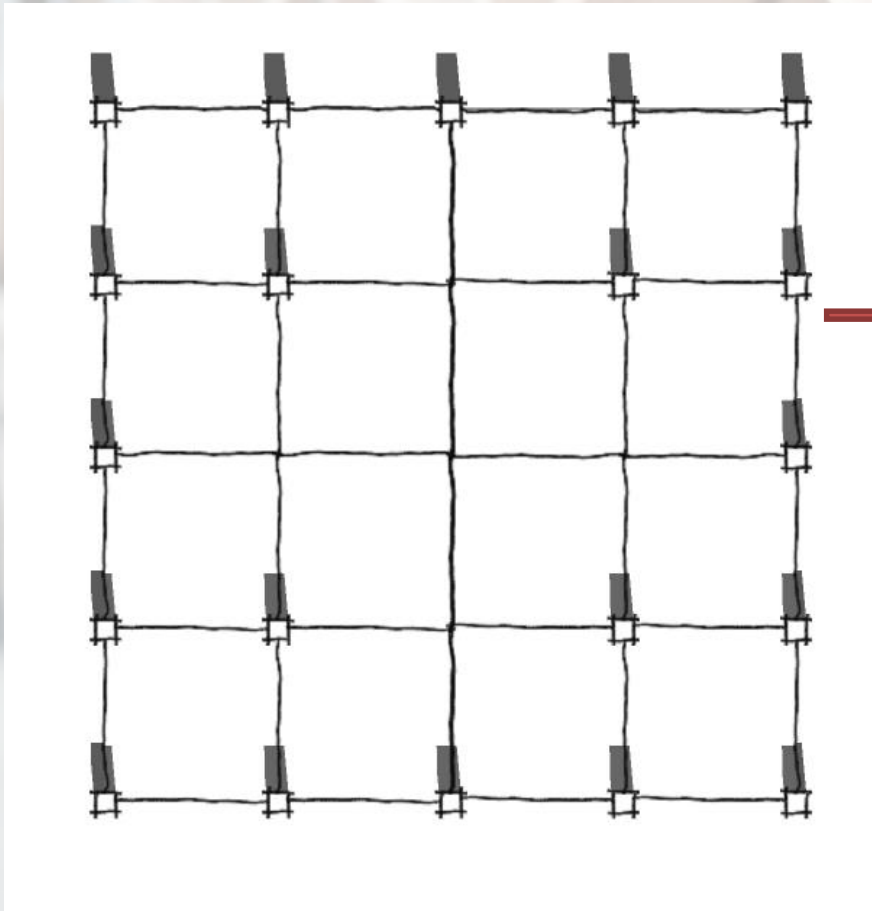

Perpaduan struktur kolom dengan Dinding pemikul

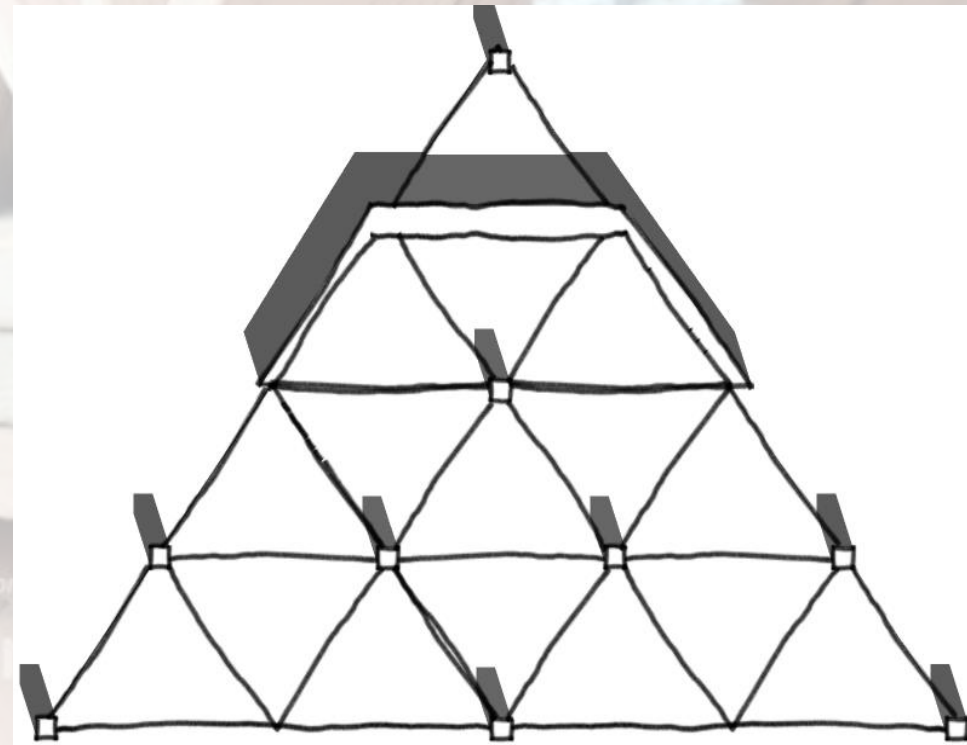
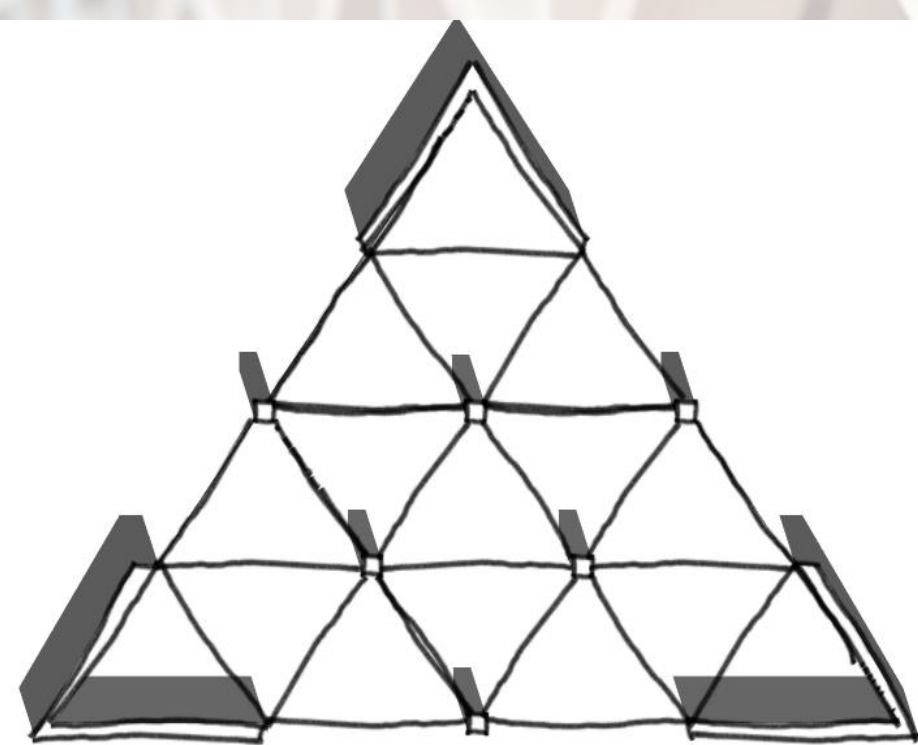

Contoh Grid radial

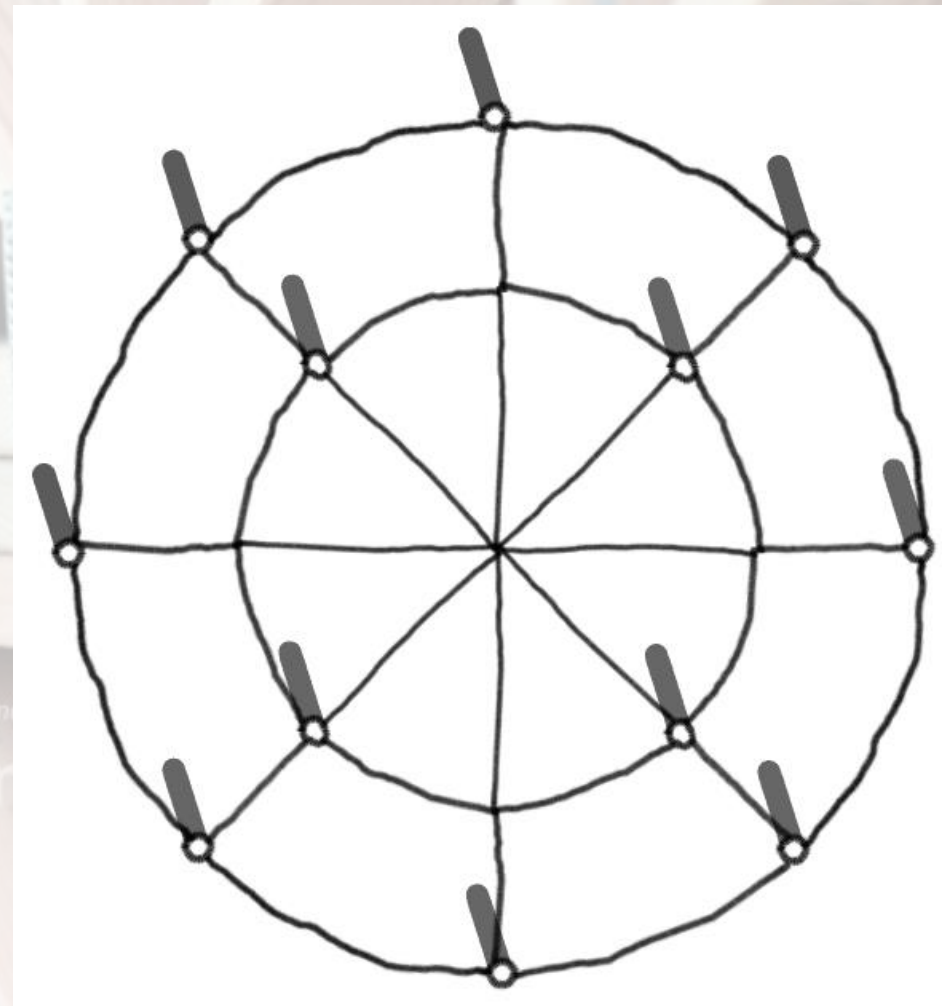
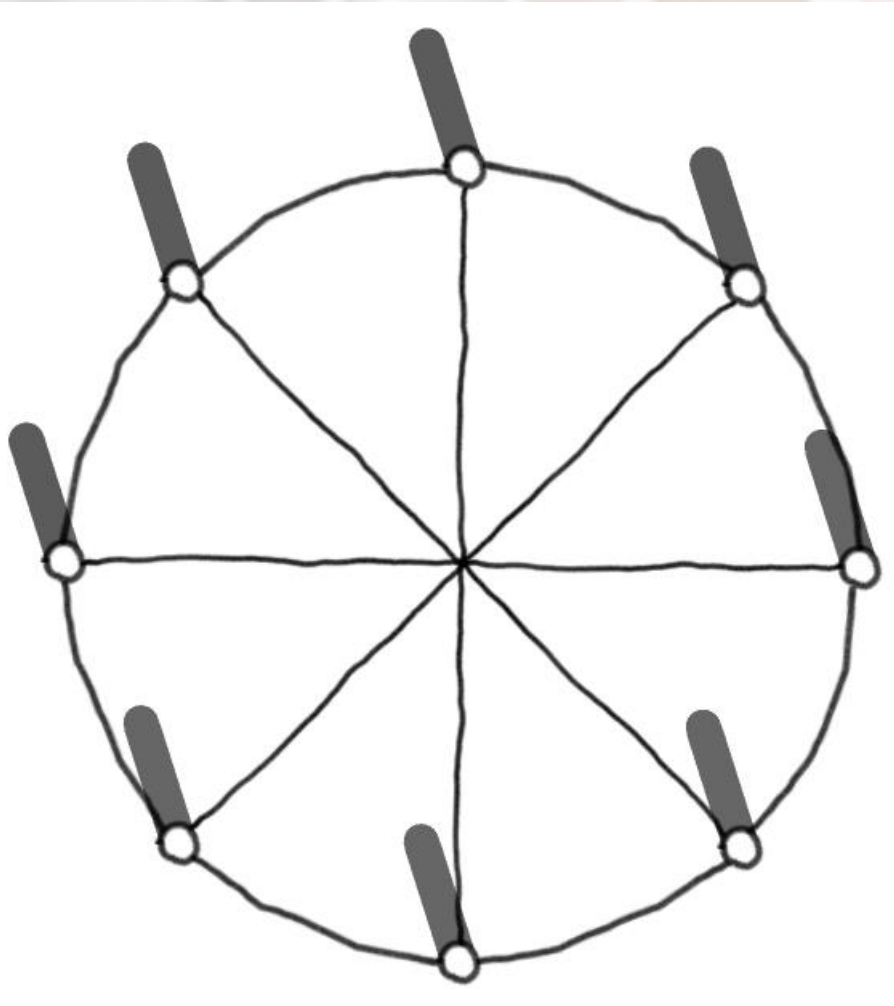

Perpaduan struktur kolom dengan Dinding pemikul

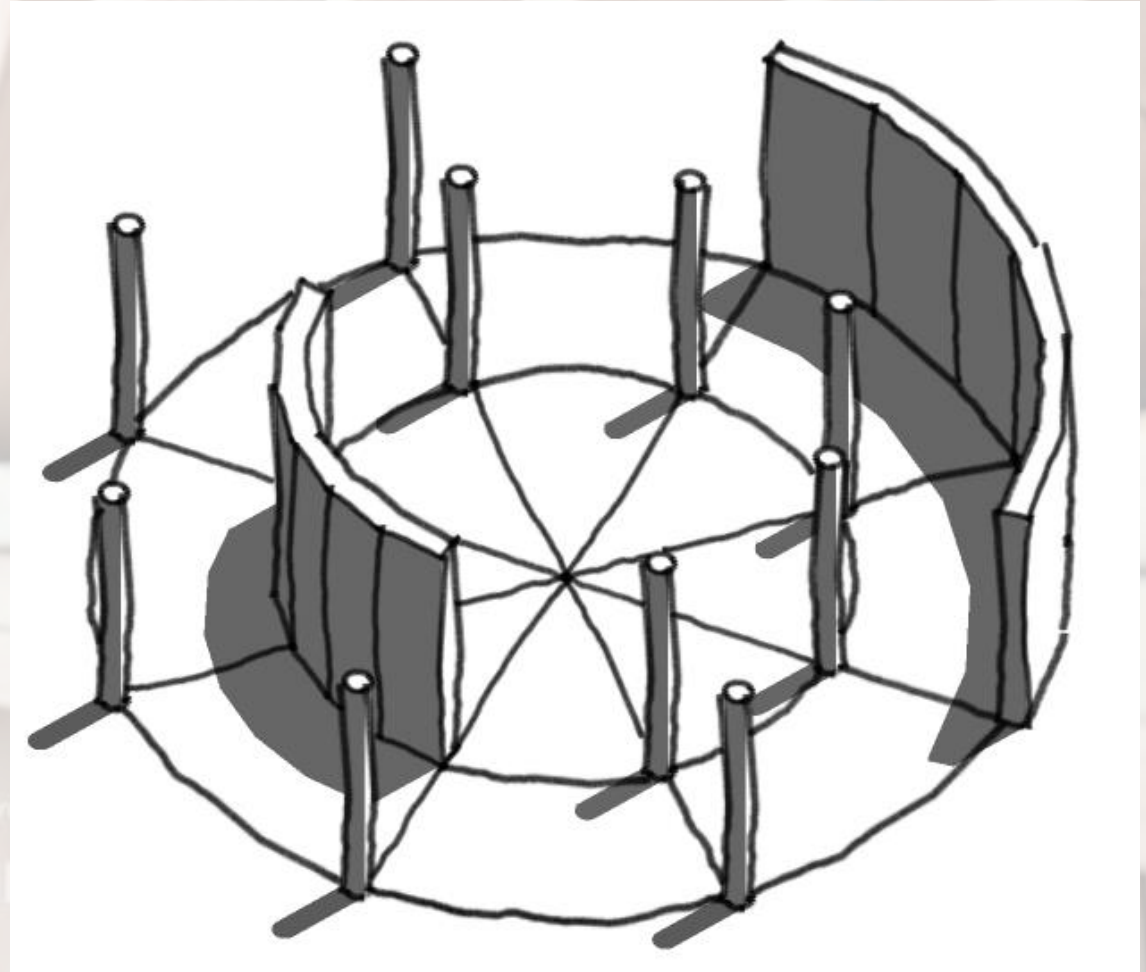
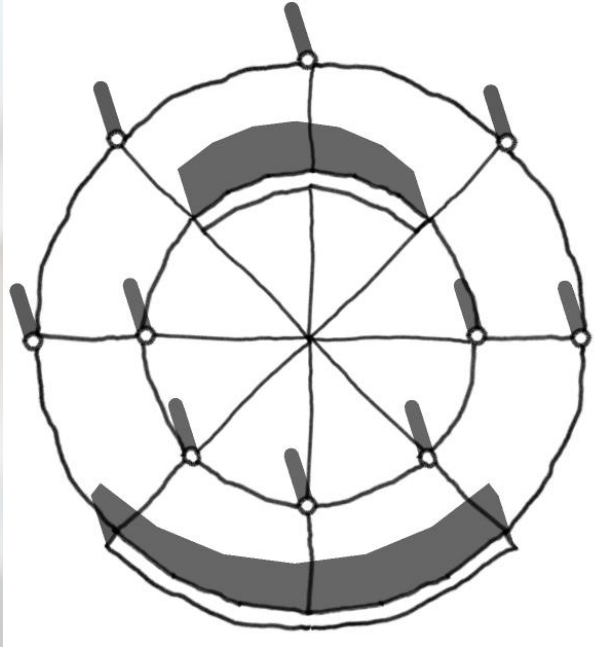

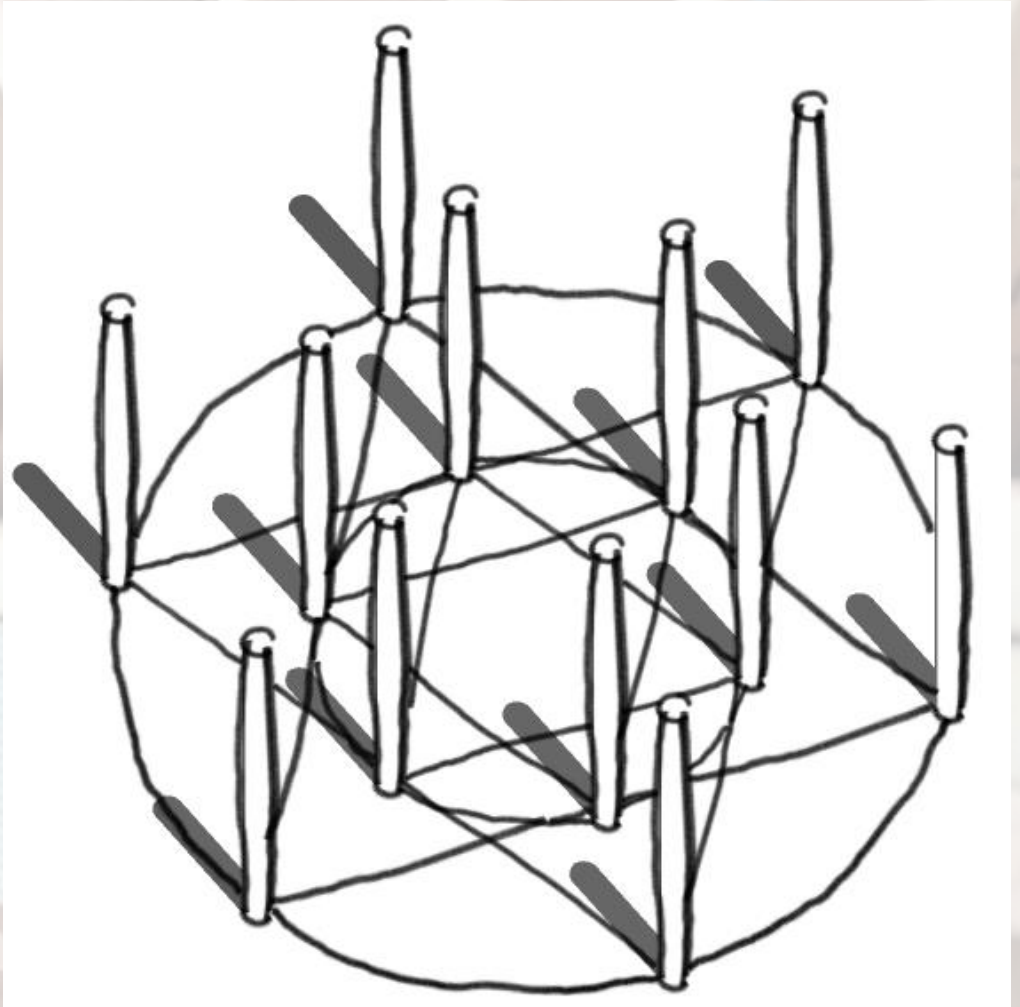
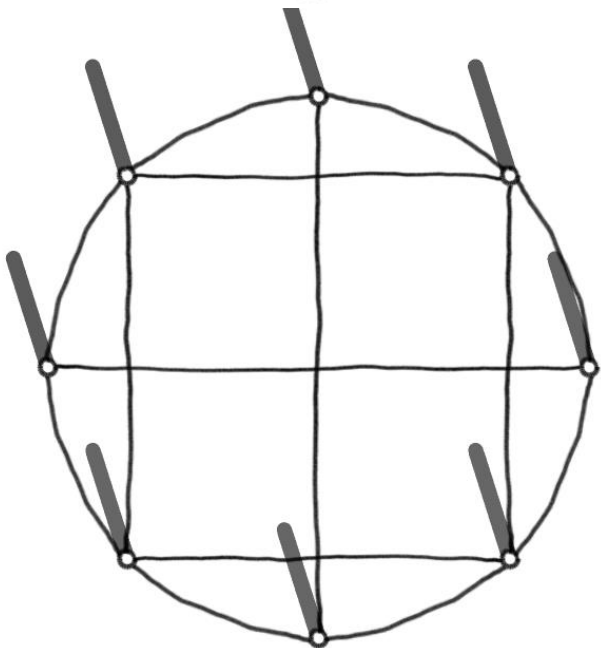
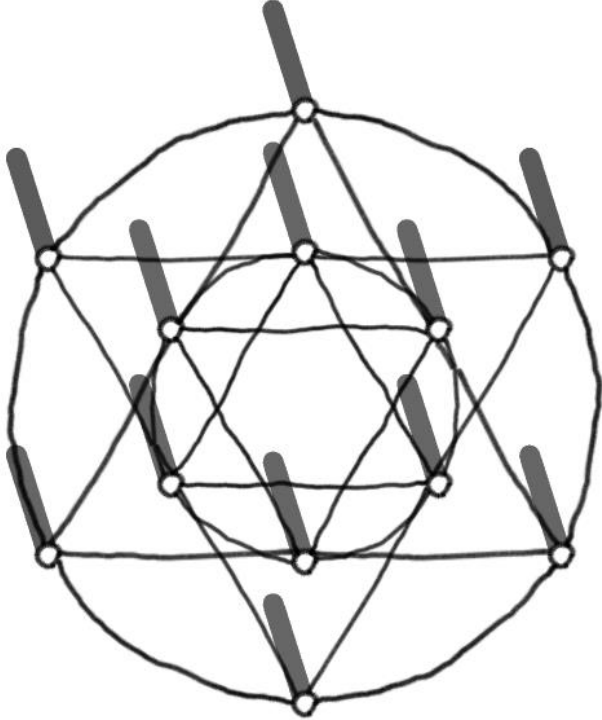

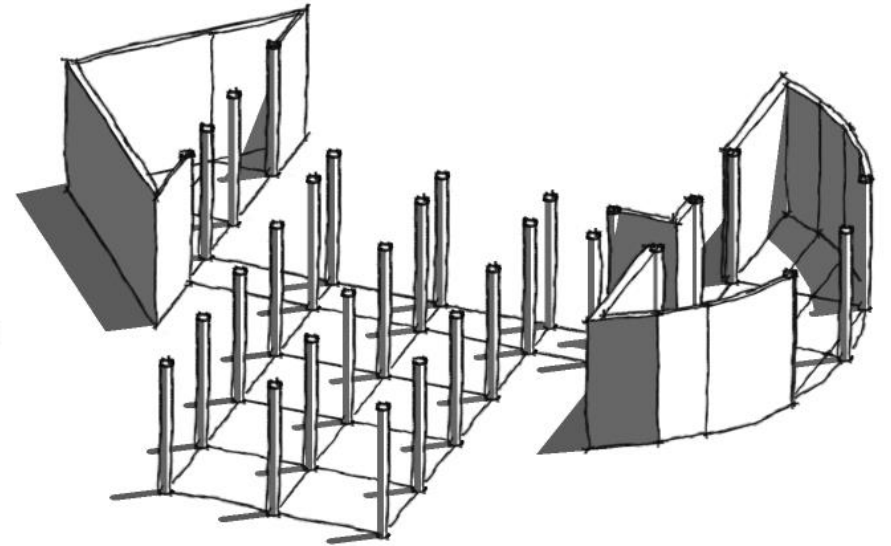
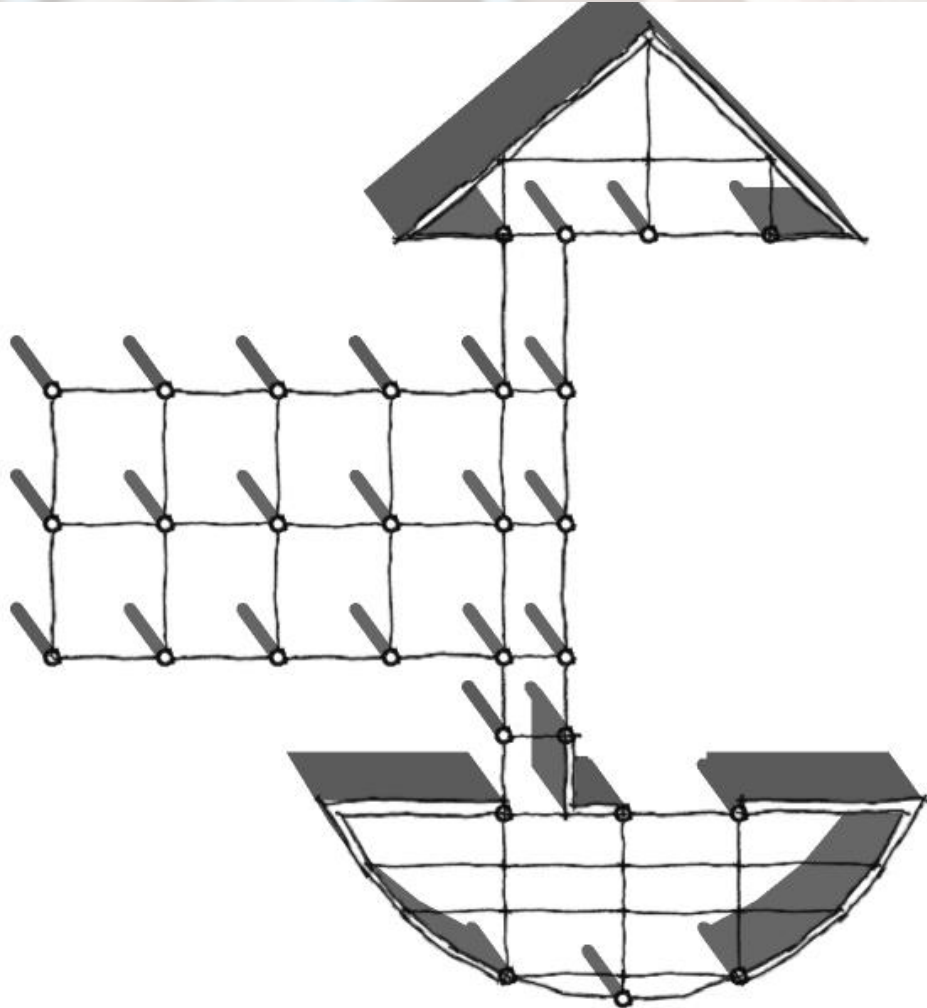

PENENTUAN DESAIN ATAP



Jolopong



Perahu Kumureb

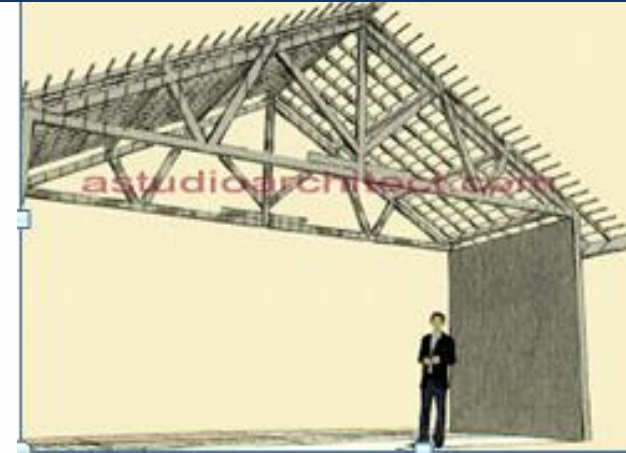

Julang Ngapak



Badak Heuay



Tagog Anjing



Capit Gunting



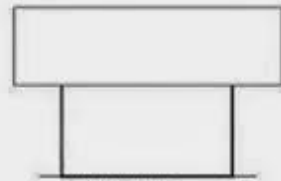

PANDANGAN MUKA

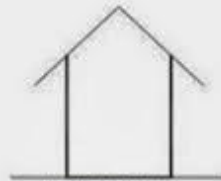

PANDANGAN SAMPING



POTONGAN Bujur (I-I)



POTONGAN MELINTANG (II-II)

ATAP PELANA

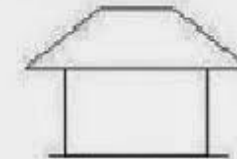

PANDANGAN MUKA



PANDANGAN SAMPING

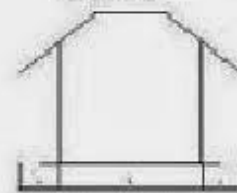

POTONGAN Bujur (I-I)

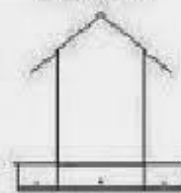

POTONGAN MELINTANG (II-II)

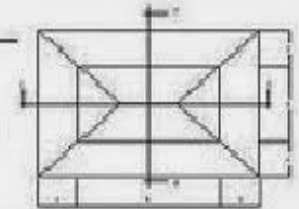

PANDANGAN ATAS

ATAP LIMASAN

JENIS ATAP

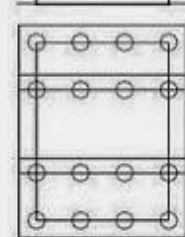
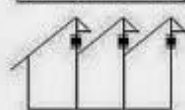
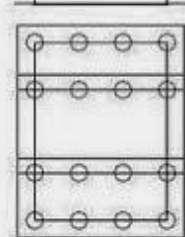

ATAP GERIGI / GERGAJI

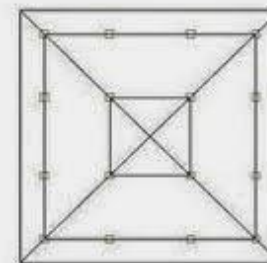
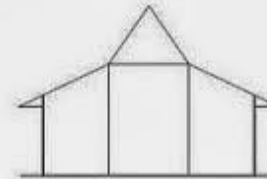

DENGAN SOKO GURU

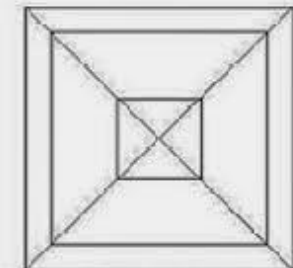
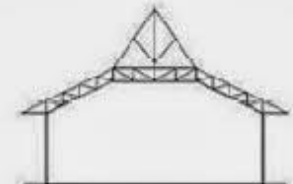

TANPA SOKO GURU

ATAP JOGLO

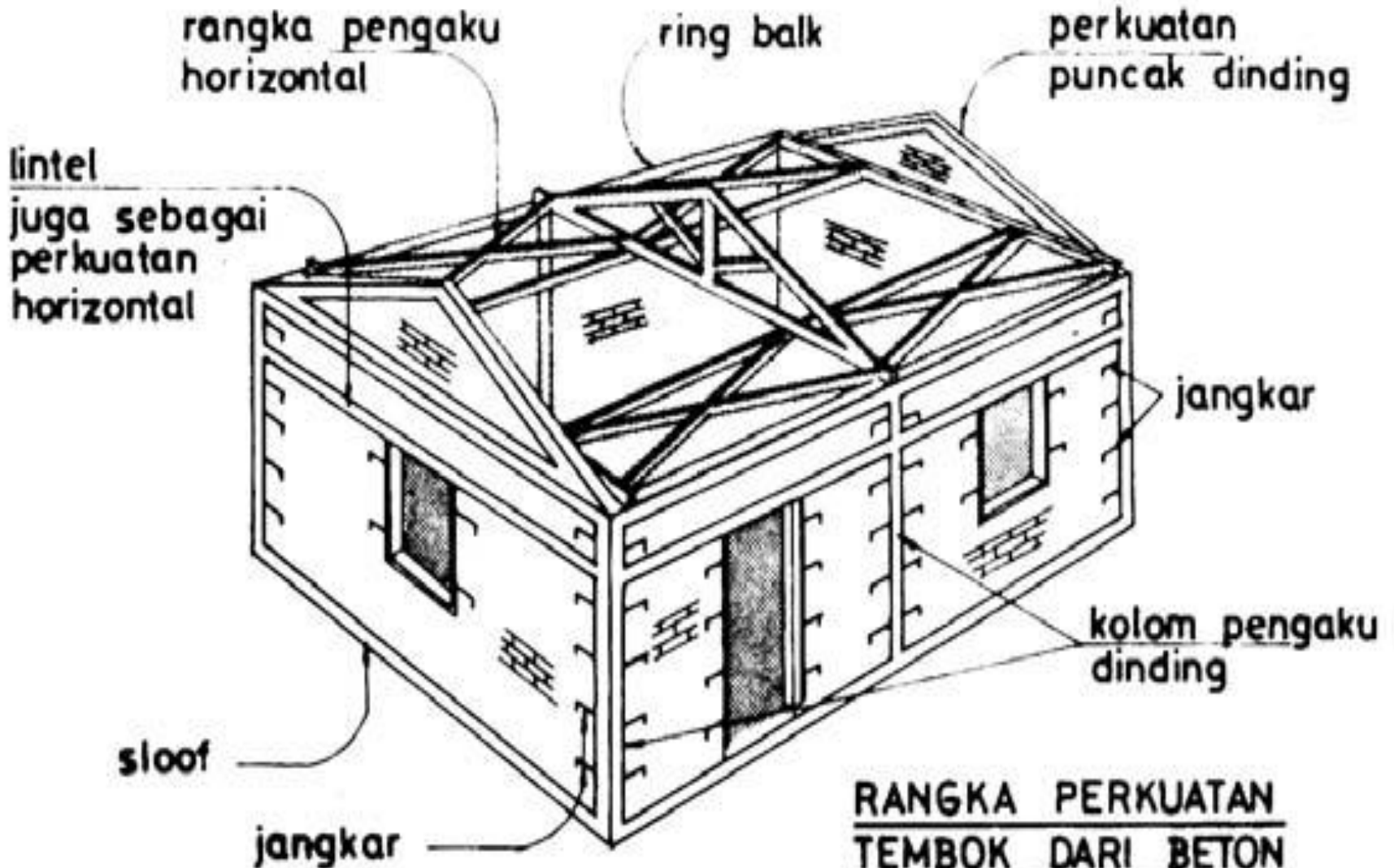

RANGKA PERKUATAN
TEMBOK DARI BETON
BERTULANG

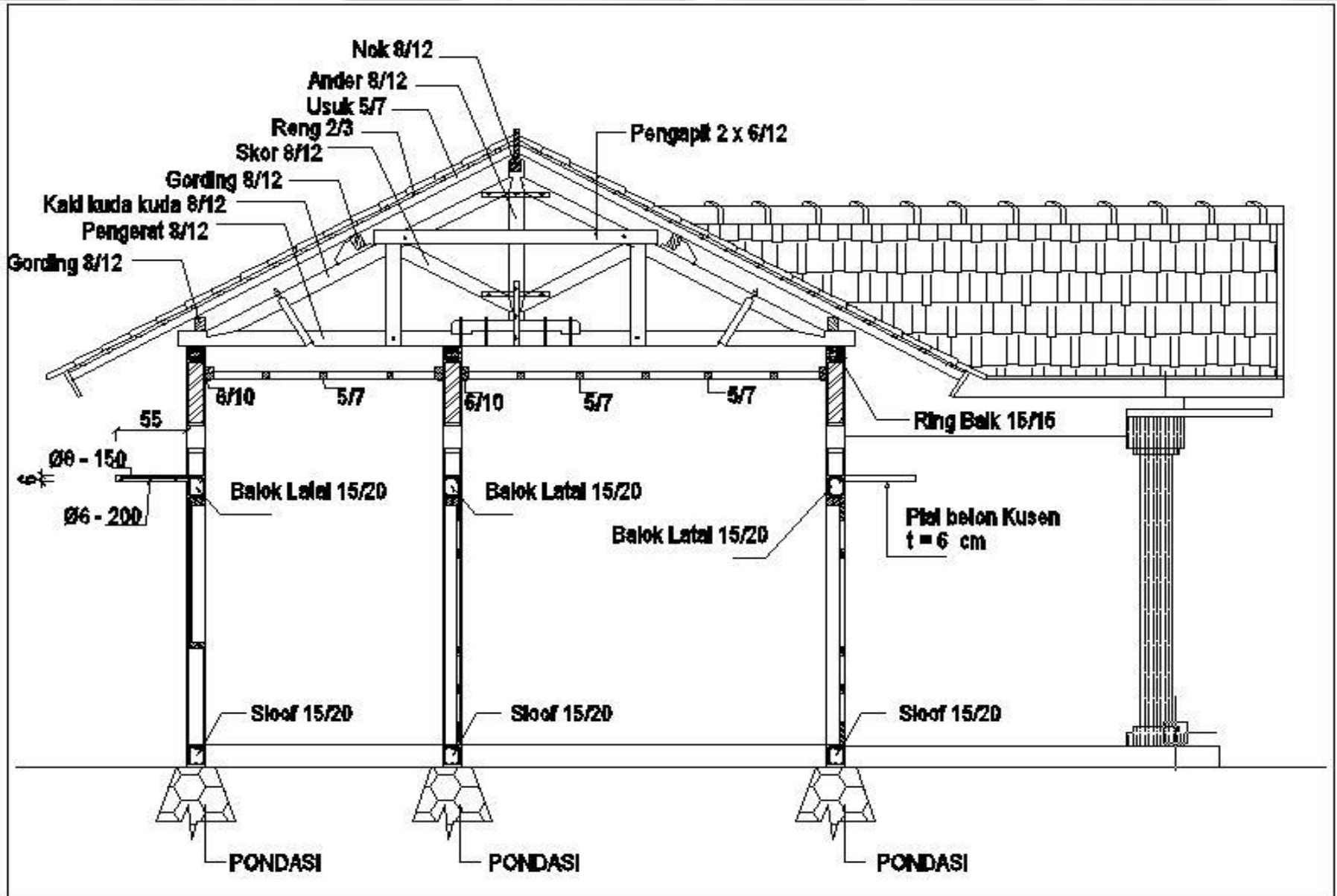

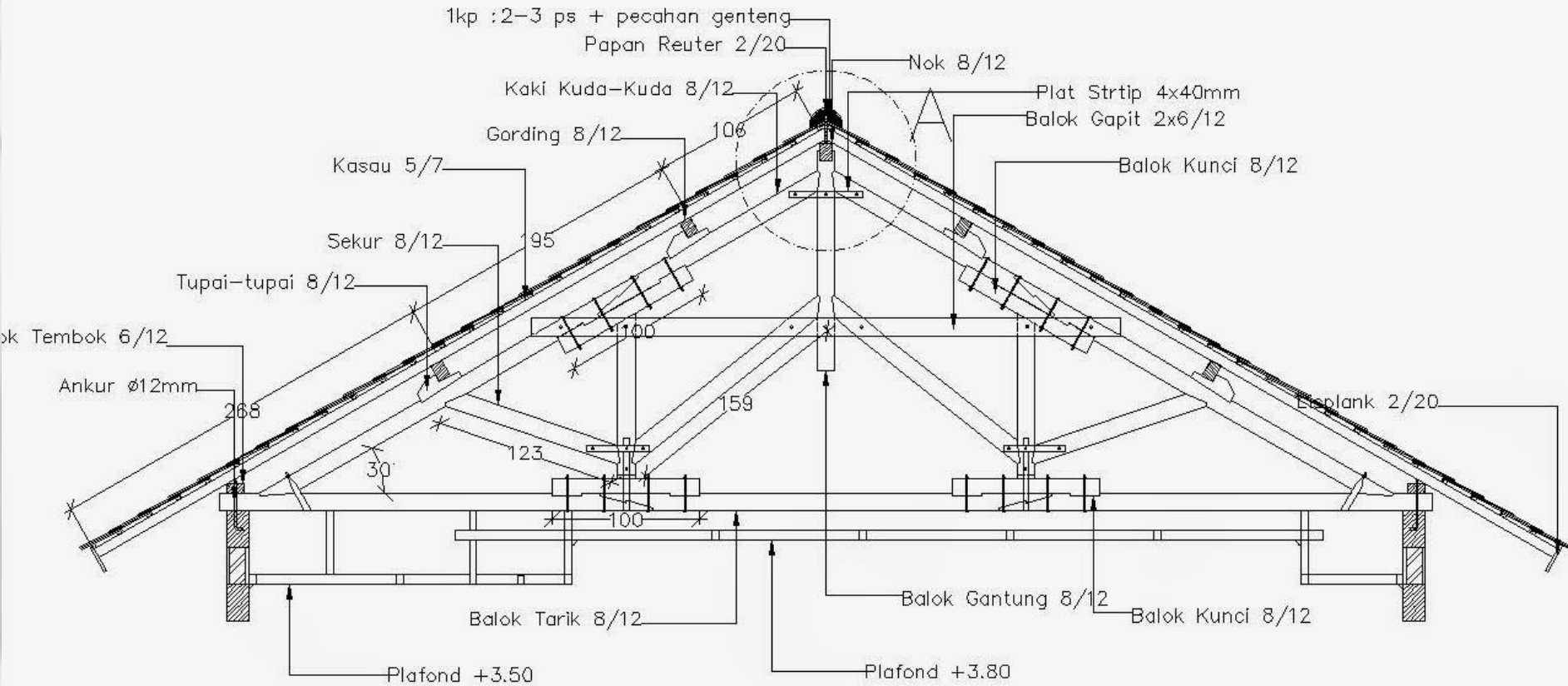

BENTUK KUDA-KUDA BERDASARKAN BENTANG

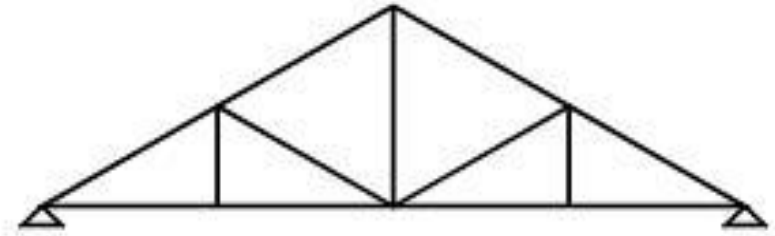
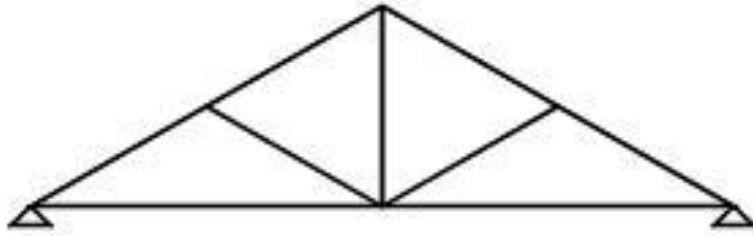

Kuda-Kuda Bentang 3-4 Meter

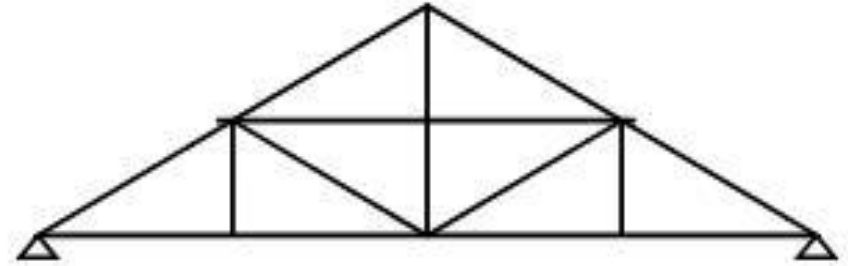
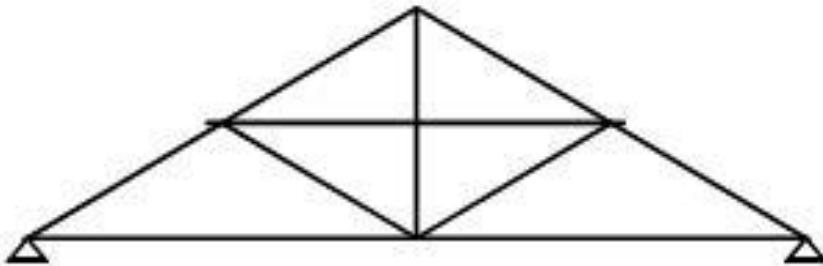

Kuda-Kuda Bentang 4-8 Meter

BENTUK KUDA-KUDA BERDASARKAN BENTANG

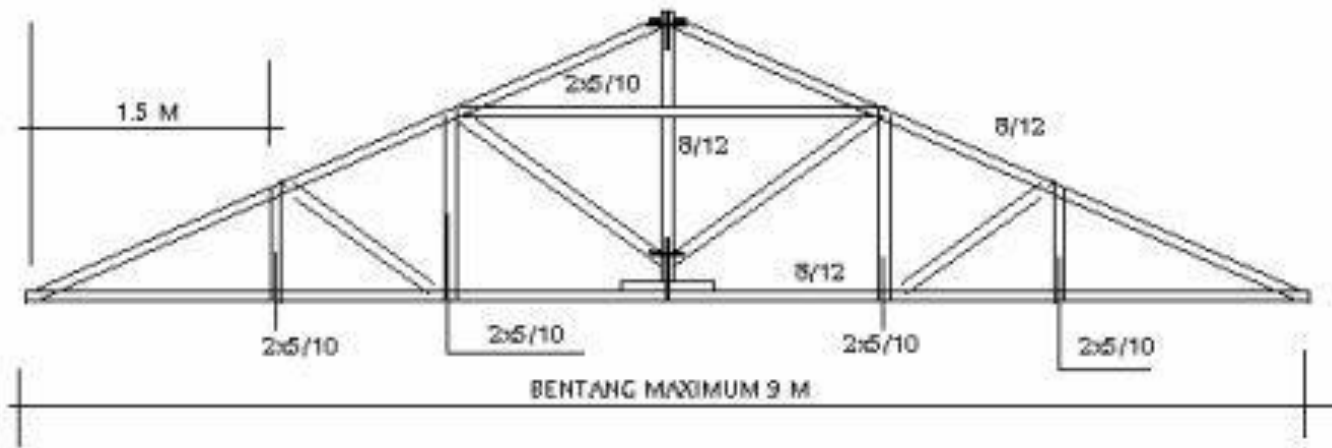
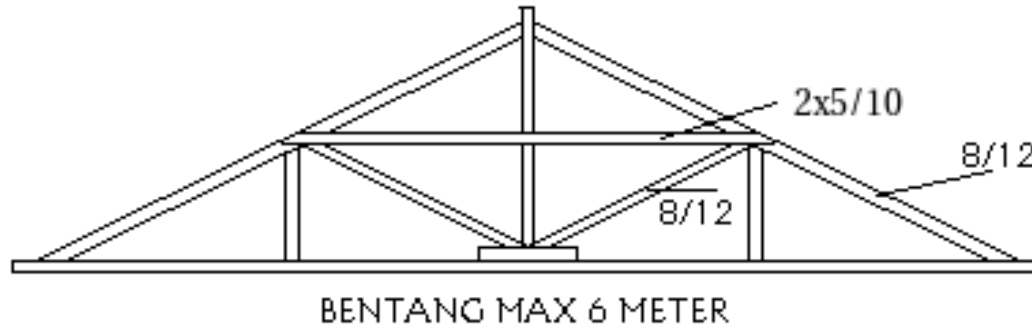

BENTUK KUDA-KUDA BERDASARKAN BENTANG

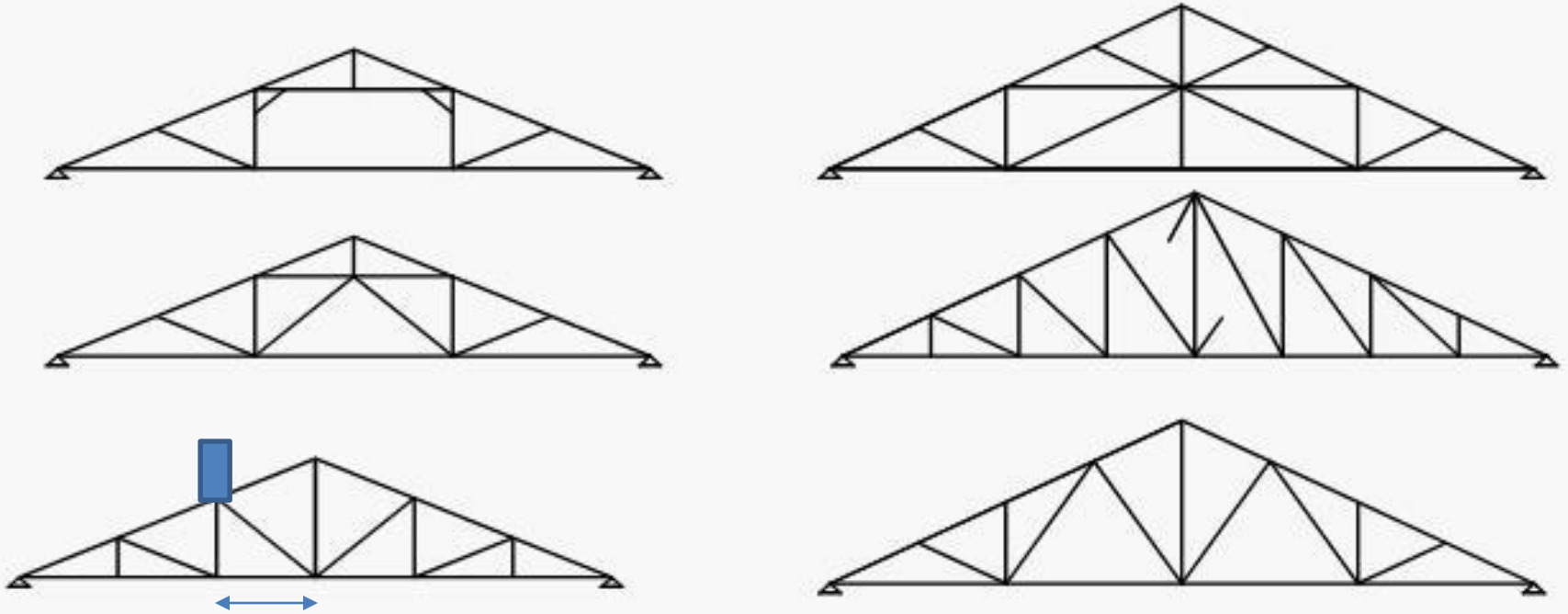

Kuda-Kuda Bentang 9-16 Meter

MACAM-MACAM KUDA-KUDA KUDA-KUDA KAYU

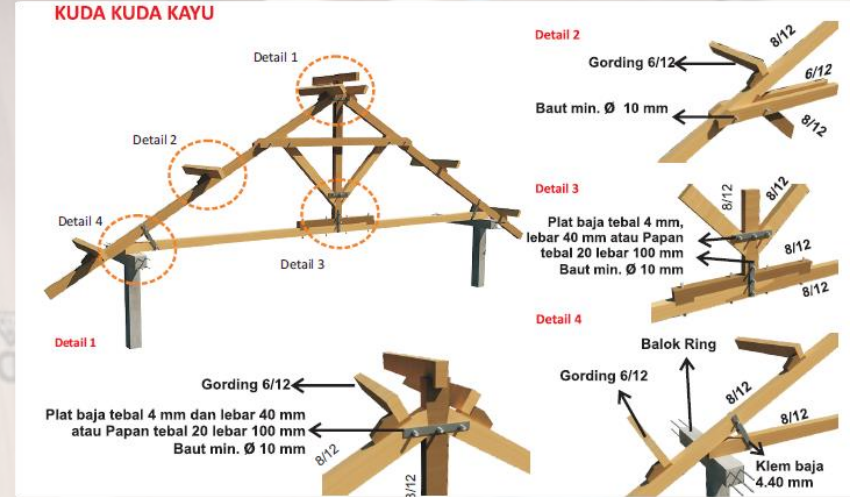

MACAM-MACAM KUDA-KUDA KUDA-KUDA BETON

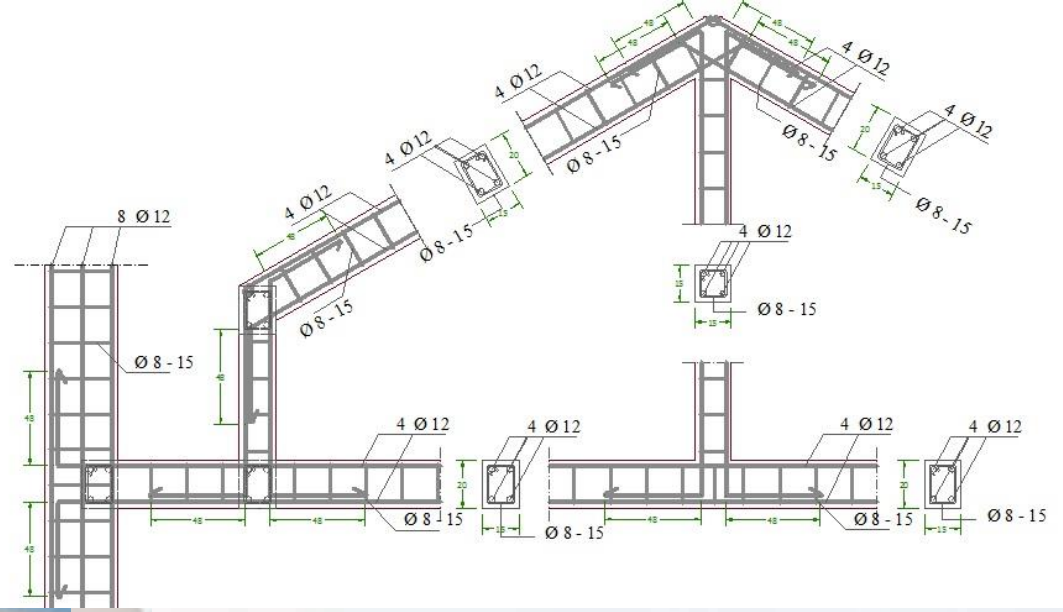



**BENTUK
ATAP**

**GRID
STRUKTUR**

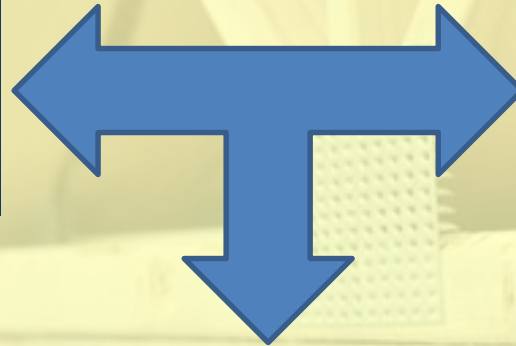

DESAIN STRUKTUR

ESTETIKA BANGUNAN

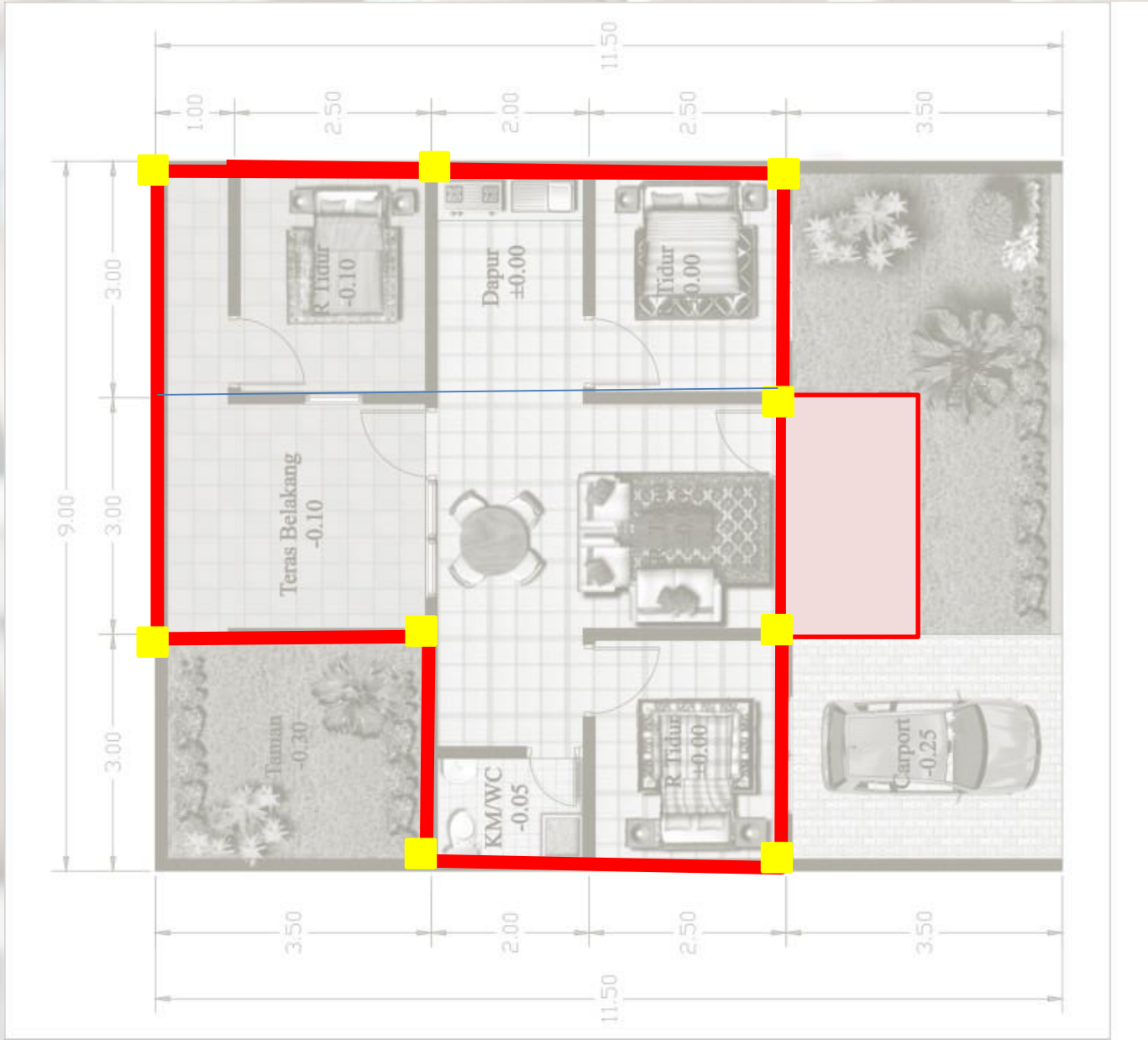

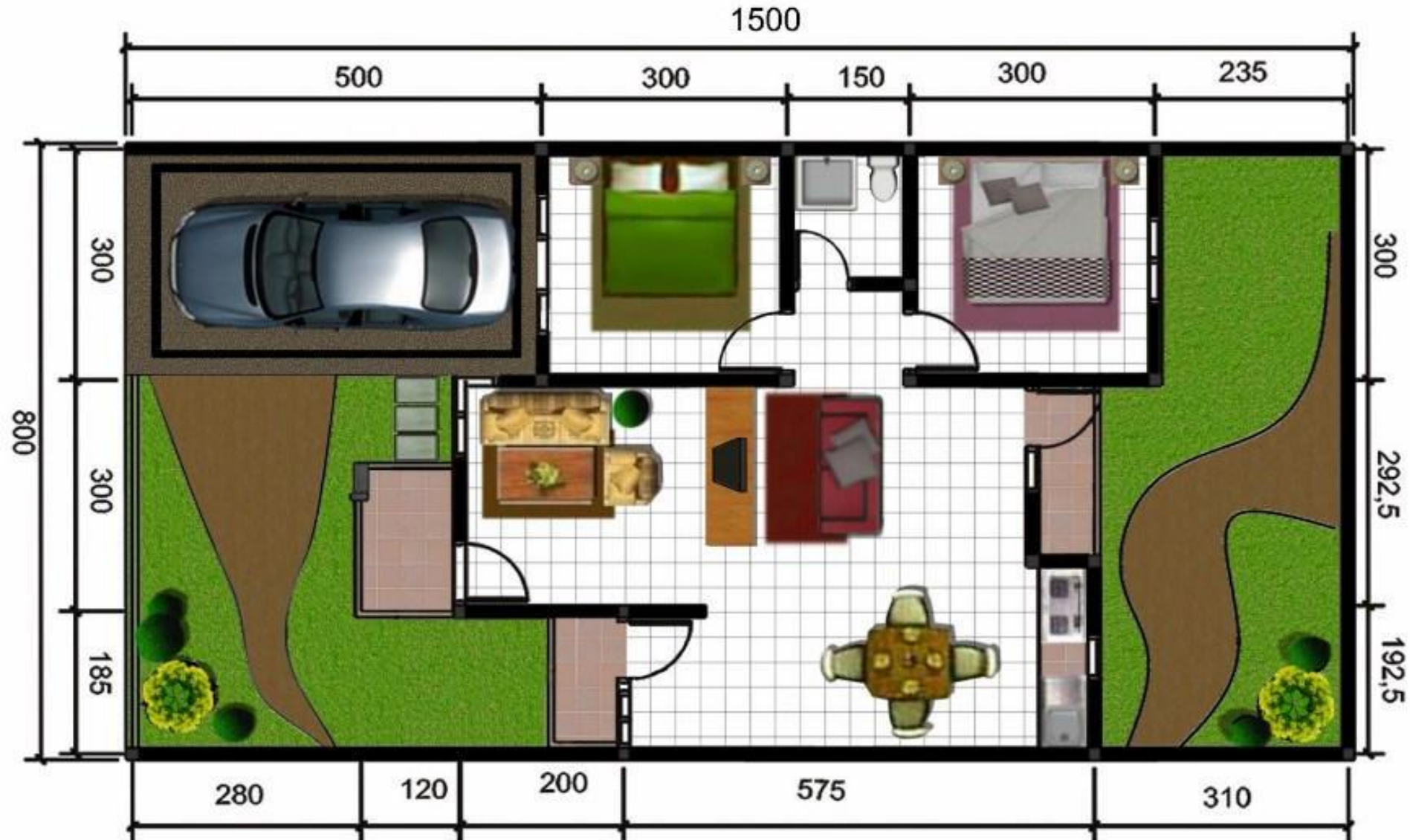

TUGAS MINGGU 5-6

DESAIN GRID STRUKTUR

DESAIN ATAP

- **BUATLAH DENAH BANGUNAN SEDERHANA UKURAN $\pm 100\text{m}^2$ (BUAT SEKREATIF MUNGKIN)**
- **BUATLAH RENCANA GRID KOLOM STRUKTURNYA (DISERTAI UKURAN SESUAI PERTEMUAN SEBELUMNYA)**
- **BUATLAH DESAIN OUTLINE RENCANA ATAPNYA**
- **BUATLAH RENCANA ATAP DISERTAI PERLETAKAN KUDA-KUDANYA.**
- **GAMBAR PADA KERTAS A3 SKALA 1:100 (GAMBAR LENGKAP DENGGA KETERANGAN DAN UKURAN)**
- **SCAN/FOTO GAMBAR TUGAS DAN KUMPULKAN MELALUI ELEARNING. GRID STRUKTUR MAKSIMAL 7 APRIL 2021 JAM 15.00WIB. RENCANA ATAP MAKSIMAL 10 APRIL 2021 JAM 15.00WIB**